



**Pasha Balloons  
Maintenance Manual**

*Ed. 5  
Rev. 0*

*Date 19 August 2021*

# HOT AIR BALLOON MAINTENANCE MANUAL

THIS MANUAL CONTAINS THE INFORMATION RELATED TO HOT AIR  
BALLOONS CERTIFIED UNDER TYPE CERTIFICATES TR.BA.001 AND  
[TR.BA.002](#)

THE TECHNICAL CONTENT OF THIS DOCUMENT IS APPROVED  
UNDER THE AUTHORITY OF DOA REF.TR.21J.003

MANUFACTURER:

PASHA BALLOONS URETIM

BAHCELIEVLER MAH. ATATURK CAD. NO. 18

ORTAHISAR/URGUP/NEVSEHIR/TURKEY

[WWW.PASHABALLOONS.COM](http://WWW.PASHABALLOONS.COM)

INFO@PASHABALLOONS.COM

## TABLE OF CONTENTS

<b>TABLE OF CONTENTS .....</b>	<b>2</b>
<b>1. GENERAL .....</b>	<b>6</b>
1.1. Introduction .....	6
1.2. Parts and Materials .....	6
1.3. Pilot Owner Maintenance .....	6
1.4. Systems description .....	7
1.4.1. Envelope description .....	7
1.4.2. Basket description .....	9
1.4.3. Burner description .....	10
1.5. Trouble-shooting information .....	12
<b>2. ENVELOPE REPAIR INSTRUCTIONS .....</b>	<b>13</b>
2.1. General .....	13
2.1.1. Permitted damage .....	13
2.1.2. Stitching .....	13
2.1.3. Envelope thread .....	13
2.1.4. Balloon Seam .....	13
2.1.5. Fabric repair limitations .....	13
2.2. Fabric repairs .....	14
2.3. Tape repairs .....	15
2.4. Control lines .....	16
2.5. Flying cables .....	16
2.6. Parachute replacement .....	16
2.7. Velcro replacement .....	17
2.8. Temperature indicators (flag and tag) .....	17
2.9. Preventive maintenance .....	17
<b>3. BASKET REPAIR INSTRUCTIONS.....</b>	<b>18</b>
3.1. General .....	18
3.1.1. Permitted damage .....	18
3.1.2. Damage prevention and material information.....	18
3.2. Wicker repair.....	18
3.3. Bottom leather repair.....	18
3.4. Top leather repair .....	18
3.5. Rod covers replacement.....	18
3.6. Padded walls replacement .....	19



# Pasha Balloons Maintenance Manual

Ed. 4  
Rev. 0

Date 19 March 2021

3.7.	Runners replacement .....	19
3.8.	Plywood replacement.....	19
3.9.	Wires replacement .....	19
<b>4.</b>	<b>BURNER REPAIRS .....</b>	<b>20</b>
4.1.	General .....	20
4.2.	Main valve .....	20
4.3.	Liquid valve.....	20
4.4.	Pilot light.....	21
4.5.	Pressure gauge.....	21
4.6.	Burner coil .....	21
4.7.	Fuel hose .....	21
<b>5.</b>	<b>RESERVED .....</b>	<b>21</b>
<b>6.</b>	<b>MAINTENANCE SCHEDULES .....</b>	<b>22</b>
6.1.	General .....	22
6.2.	Scheduled Inspections.....	22
6.3.	Unscheduled Inspections .....	22
6.4.	Inspection procedures .....	23
6.5.	Grab test procedure .....	28
<b>7.</b>	<b>AIRWORTHINESS LIMITATIONS.....</b>	<b>29</b>
7.1.	Life limited parts .....	29
7.2.	Structural inspection interval .....	29
7.3.	Structural Inspection procedures .....	29
<b>8.</b>	<b>PARTS LIST .....</b>	<b>30</b>

	<b>Pasha Balloons Maintenance Manual</b>	<i>Ed. 5 Rev. 0  Date 19 August 2021</i>
---	--	--

## AMMENDMENT LIST

Issue Number	Changes Description	Affected Pages	Issue Date
1	Initial issue	ALL	13-03-2019
2	New envelope models	ALL	30-07-2020
3	New basket models	1 to 5 and 8 to 26	30-09-2020
4	New basket, burner and envelope models	1 to 5 and 9 to 27	19-03-2021
5	Special shape models introduction	1,2-3,15-16,30,32	19-08-2021



# Pasha Balloons Maintenance Manual

Ed. 5  
Rev. 0

Date 19 August 2021

## LIST OF EFFECTIVE PAGES

Page	Issue number	Issue date
1	5	19-08-2021
2	5	19-08-2021
3	5	19-08-2021
4	2	30-07-2020
5	2	30-07-2020
6	2	30-07-2020
7	2	30-07-2020
8	3	30-09-2020
9	4	19-03-2021
10	4	19-03-2021
11	4	19-03-2021
12	4	19-03-2021
13	4	19-03-2021
14	4	19-03-2021
15	5	19-08-2021
16	5	19-08-2021
17	4	19-03-2021
18	4	19-03-2021
19	4	19-03-2021
20	4	19-03-2021
21	4	19-03-2021
22	4	19-03-2021
23	4	19-03-2021
24	5	19-08-2021
25	4	19-03-2021
26	5	19-08-2021
27	4	19-03-2021
28	4	19-03-2021
29	4	19-03-2021
30	4	19-03-2021

	<b>Pasha Balloons Maintenance Manual</b>	<i>Ed. 2 Rev. 0 Date 30 July 2020</i>
---	--	---

## 1. GENERAL

### 1.1. Introduction

This manual sets out the procedures and requirements to repair Pasha Balloons products.

The last version of this manual will be published at Pasha Balloons website (technical support section).

### 1.2. Parts and Materials

All repairs should be made with parts and materials approved by Pasha Balloons in this Maintenance Manual. All needed parts should be found in section 8 of this Manual. For further information, or parts not specified, contact Pasha Balloons.

### 1.3. Pilot Owner Maintenance

The following list of tasks are considered Pilot owner Maintenance. Pilot-owner tasks are only allowed when the owner holds a valid pilot license and certificate of registration shows it belongs to a single person or club, but not a company.

All this task should be recorded in balloon logbook and correctly signed.

Pilot-owner tasks are:

- Replacement of control lines.
- Replacement of karabiners.
- Replacement of temperature flag.
- Replacement of scoop or skirt.
- Sticky patch repair of envelope fabric.
- Bottom leather repair or replacement.
- Top leather repair or replacement.
- Rod covers repair or replacement.
- Padded covers of basket repair or replacement.
- General cleaning of burner.

	<b>Pasha Balloons Maintenance Manual</b>	<i>Ed. 2 Rev. 0 Date 30 July 2020</i>
---	--	---

## 1.4. Systems description

### 1.4.1. Envelope description

Envelopes are made of high tenacity nylon fabric sewn in panels. The fabric is coated to make it airtight inside. All the main loads on the envelopes are carried by polyester load tapes. Horizontal tapes act as rip stoppers so that any damage to the envelope will be limited in extent.

The base panels of the balloon are made from Nomex heat resistant fabric so that the nylon is kept at a sufficient distance from the flame to prevent heat damage. The lower ends of the load tapes are formed into rigging loops to which stainless steel cables, called flying cables, are attached. These steel cables are grouped in 4 or 8 groups and attached with a steel carabiner to the load frame.

Envelope is fitted with a 'Parachute' deflation system operated by a control line from the basket to release hot air outside, 'Fast deflation system' operated by a control line from the basket to release massive quantities of hot air outside and it must be used only below 10m height and for landing procedure. Envelope may also be fitted with rotation vents, which allow envelope to rotate left or right side from vertical axis. Ropes for rotation vents are differentiated as left rotation corresponds to black cord and right rotation corresponds to green rope.

The base of the balloon may be fitted with a Scoop or skirt. This improves the performance of the balloon when taking off or tethering in wind, and during flight in turbulent conditions.

Balloon envelope does not have any assembly part, so no further instruction is required for this issue.

Balloon envelope must be handled with care and considering that any pointed object or sharp edge could damage the fabric. It also must be always handed by human force; it is not allowed to drag it with mechanical forces as they could damage the structure.

The following sketch shows all parts of the balloon:

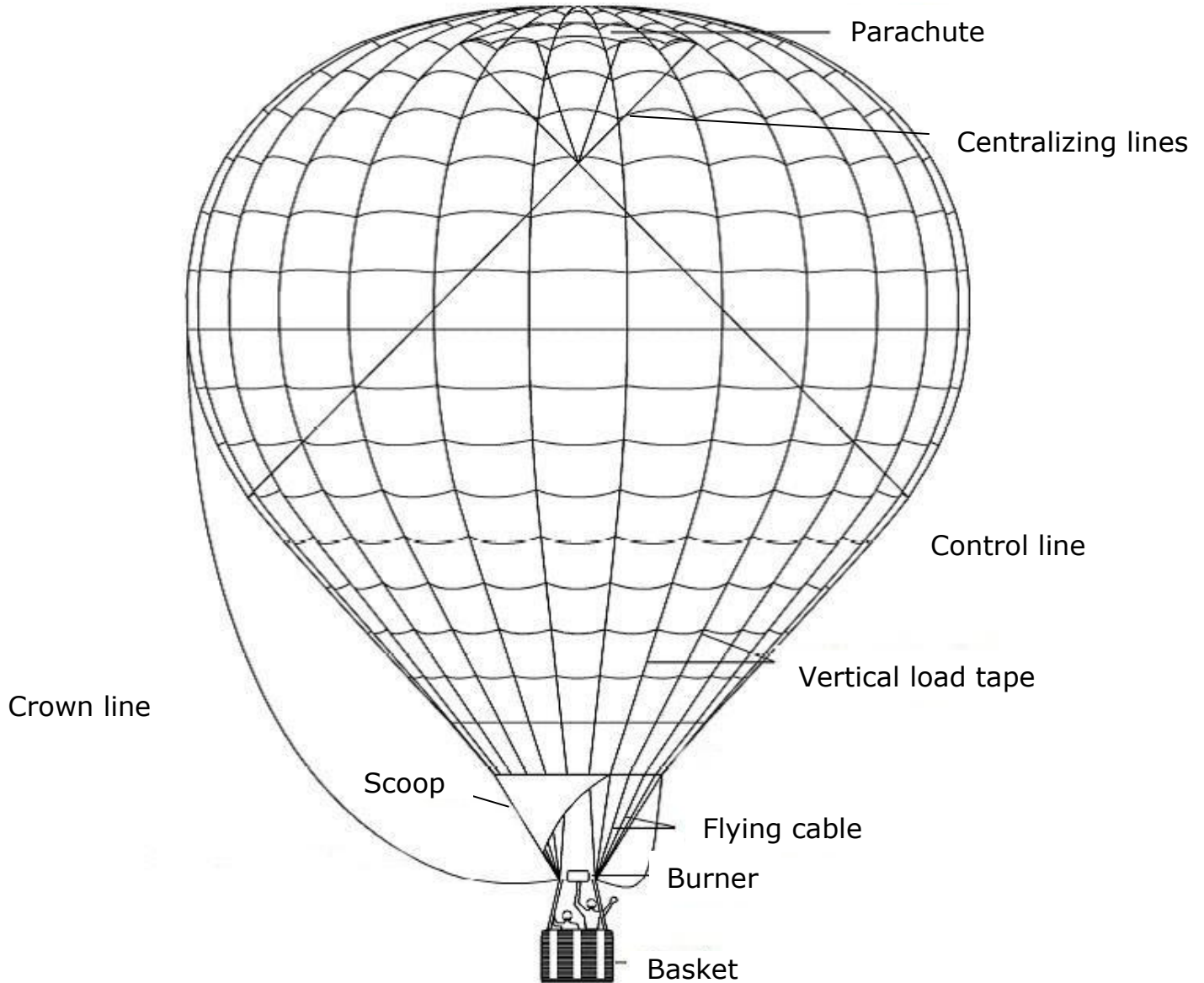

*Figure 11. Envelope general view*



## 1.4.2. Basket description

Pasha Balloons baskets are wicker woven baskets designed to fly under hot air balloons. These are classical baskets used in the industry for many years.

Baskets are manufactured using a plywood base attached to metallic structure and wooden poles creating a mesh. This mesh is “woven” with wicker due to flexibility of the material. Suspension structure is placed inside the woven wicker and pass beneath the basket being protected of any wear or abrasion. Leather and foam are used to protect passenger of metallic and plastic parts.

Nylon poles are used to keep load frame in position during inflation and landing. They are covered with padded leather to protect passengers and pilot during landing.

Basket is fitted with handholds for pilot and all passengers. Also, it is equipped with restraint system fitting point for pilot and all passengers.

The following drawing shows all parts of the basket:

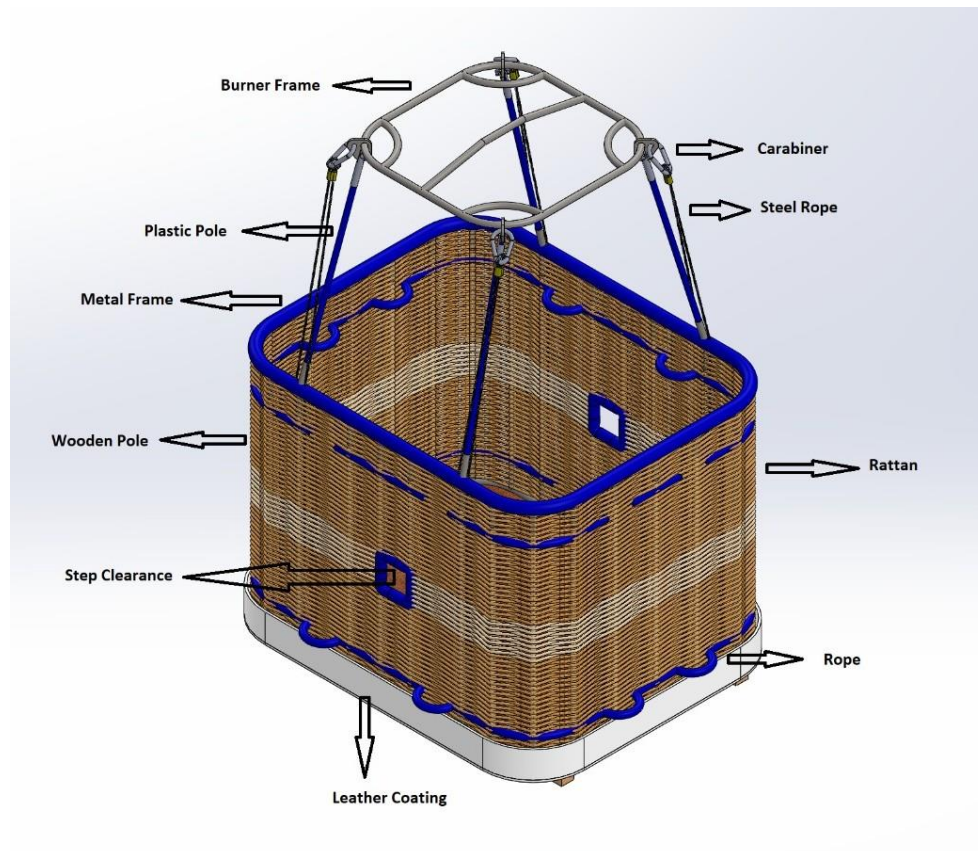

Figure 22. Basket general view

### 1.4.3. Burner description

Burner is the source of heat for hot air balloons. Liquid propane is used to heat air inside the hot air balloon envelope. Pasha Balloons burner are available in double, triple and quadruple configuration. These pictures show how Pasha Balloons burner look.



*Figure 33. Double burner general view*



*Figure 44. Triple burner general view*



*Figure 55. Quadruple burner general view*

Burner consist in a group of valves and subassemblies. These subassemblies are:

#### Main burner

Main valve (on/off) controls the flow of fuel. This fuel passes through burner coil to increase the temperature of the fuel and through jets ring before combustion. Main valve has flat or rugged surface to differentiate fuel flow input.

#### Whisper burner

Whisper valve (on/off) controls the flow of fuel directly burnt without going through burner coil. The flame produced is less powerful but more silent. When continuous use of whisper burner, frozen droplets of propane may appear at the jet nozzle, STOP usage of whisper burner when it is advertised.

#### Pilot light

Pilot light provides continuous flame for burner ignition. Fuel passes through pilot light valve (rotary valve) and through pilot light regulator to provide a continuous vapour fuel flow. Every pilot light has its own piezo igniter which allows pilot light relighting in case of flame out.

	<b>Pasha Balloons Maintenance Manual</b>	<i>Ed. 4 Rev. 0 Date 19 March 2021</i>
---	--	--

Pressure gauge

Pressure gauge is fitted to every fuel supply to indicate the pressure of the fuel inside the block.

Fuel supply

One fuel supply is fitted to every burner unit (two, three or four fuel supplies depending on burner configuration). These fuel hoses are coloured at both ends to easily determine fuel tank source for each burner.

#### 1.5. Trouble-shooting information

Hot air balloons envelopes, baskets and burners are not a complex product that would require trouble-shooting information to find what could be the origin of the malfunction. As there is no mechanism, no trouble-shooting procedure is established. For further information, please contact Pasha Balloons.

	<b>Pasha Balloons Maintenance Manual</b>	<i>Ed. 4 Rev. 0 Date 19 March 2021</i>
---	--	--

## 2. ENVELOPE REPAIR INSTRUCTIONS

### 2.1. General

#### 2.1.1. Permitted damage

Permitted damage to the fabric in the lower third of the balloon is permitted while it is affecting no more than 2 panels with a maximum damage of 100mm.

Holes below 10mm diameter are not considered as damage and balloon can fly with them.

#### 2.1.2. Stitching

Following stitching characteristics are required to repair Pasha Balloons envelopes.

Stitch type: Lock Stitch

Stitch length: 5-8 stitches per 25mm

Twin needle spacing: *5/16" (8mm) or 3/8" (9,5mm)*

#### 2.1.3. Envelope thread

Thread to be used is nylon three-strand bonded thread. It must be metric 40 and must make contrast with envelope fabric.

#### 2.1.4. Balloon Seam

The seam used is French Fell Seam (balloon seam). Both folded edges of fabric must be penetrated by both rows of stitching. The end of stitching line should be back tacked between 10 and 30 mm. When a bobbin needs to be changed, a minimum length of 150 mm must be overlapped.

#### 2.1.5. Fabric repair limitations

Maximum number of panels to be replaced at one time must be limited to 10% of the total envelope panels. When the extension of the repair goes beyond this limit, written approval from Pasha Balloons is required.

Scoop repair is not included in this limitation and can be repaired replacing panels.



## **Pasha Balloons Maintenance Manual**

*Ed. 4  
Rev. 0  
Date 19 March 2021*

### 2.2. Fabric repairs

#### 2.2.1. Panel replacement

To replace a panel, following steps must be followed.

1. Unpick all the stitching of the damaged panel. When a seam is covered by horizontal tape, it should be taken out to show the panel stitching. Vertical tapes will be unpicked at the same time than panel seam.
2. A non-damaged panel may be used to copy the dimensions of replaced panel.
3. The new panel should be installed using French Fell seam. 150mm overlapping seam must be used when joining to original panels. Vertical and horizontal tapes must be sewn after panel seam using 150mm overlap too.

#### 2.2.2. Strip method

Strip method may be used as an alternative to panel replacement. If damaged is closer to 25mm to any of the original seams, the seam must be unpicked, and the strip extended to the original edge of the panel. Vertical strips are used and the following steps must be followed.

1. Partially unpick the seam of top and bottom edge of the panel where damage is present (see panel replacement method if tapes are affected).
2. Remove a vertical strip of the panel allowing 30-40mm at both sides of the damage.
3. Use the removed strip to cut a new piece of fabric allowing 40mm extra at each side (for double fell seam)
4. Install the vertical strip to the original panel using double fell seam.
5. Sew the original seam with new vertical strip completing the original panel. (see panel replacement method if tapes are affected)

#### 2.2.3. Self-Adhesive patch

Self-Adhesive patch supplied by Pasha Balloons may be used when damaged extension is not bigger than 200mm (longest dimension). The procedure is:

1. Cut a piece of adhesive fabric (spinnaker type) that exceeds the damage and overlap non-damaged fabric by 25mm in all the direction.
2. Attach the adhesive fabric to the clean fabric. When ready, repeat the procedure in the other side of the panel to have adhesive both sides of the panel.
3. When damage is at hyperlast fabric or top two thirds of the envelope, stitching all around the patch must be used.

### 2.3. Tape repairs

When damage is present in any tape, identical specification tape must be used to repair it. Written approval must be obtained from Pasha Balloons to use different tape than provided by Pasha Balloons. Tape repair consist to remove any sharp edge from the damaged tape (in case of burnt tape or burnt fabric) and install a new piece of tape overlapping 1 meter each side after damaged area.

Two rows of stitching needs to be used when installing new tape and one gate of 20x50mm must be used at each end of new tape. Two more gates of 20x50mm must be stitched, one at each side of damaged tape where one meter overlap starts.

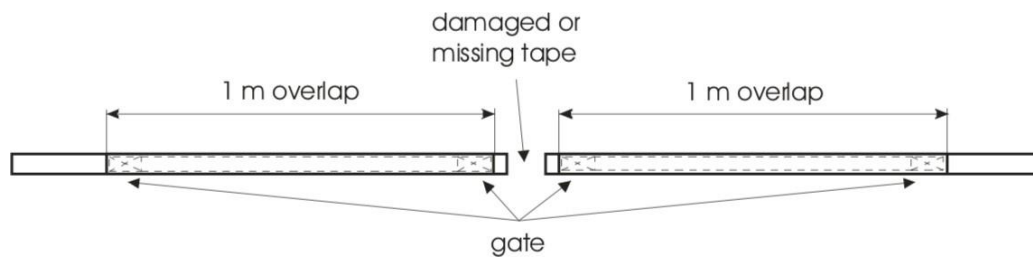

Different models of envelopes use different tape width. The following table must be checked to determine which tape is applicable to envelope models:

Model	Tape width
PH-60	18/26mm
PH-65S	18/26mm
PH-70	18/26mm
PH-75S	18/26mm
PH-80	18/26mm
PH-90	18/26mm
PH-105	18/26mm
PH-120	18/26mm
PH-135	18/26mm
PH-150	18/26mm
PH-165	18/26mm
PH-180	18/26mm
PH-210	26mm

Model	Tape width
PH-240	26mm
PH-270	26mm
PH-300	26mm
PH-335	26mm
PH-370	26mm
PH-425	26mm
PH-460	26mm
PH-500	26mm
PH-525	26mm
PS-HEART	18mm
PS-ROCKET	18mm
PS-FLAG	18mm

## 2.4. Control lines

Parachute control line is installed with around 2 meters excess to allow the extension of it when needed. If damage occurs at the beginning of the control line (close to the basket) it may be possible to extend the line to remove the damaged rope. Hot inflation is needed to check the rope is long enough to operate correctly.

## 2.5. Flying cables

No repair is allowed on flying cables, only replacement with original spares supplied from Pasha Balloons.

When replacing a flying wire, the following procedure should be followed.

1. Unpick 80-100mm of the stitching of the mouth tape around the vertical tape connecting to the damaged flying wire.
2. Unpick all the stitching of vertical tape turnback (one panel) to “open” the vertical tape and allow damaged flying cable to be removed.
3. Install the new flying cable.
4. Close the vertical tape and sew it with the turnback.
5. Install the vertical tape with nomex panel.
6. Sew the original mouth tape overlapping seam minimum of 50mm.

Different models of envelopes use different stainless steel wire diameter. The following table must be checked to determine which diameter is applicable to envelope model:

Model	Wire diameter
PH-60	3mm
PH-65S	3mm
PH-70	3mm
PH-75S	3mm
PH-80	3mm
PH-90	3mm
PH-105	3mm
PH-120	3mm
PH-135	3mm
PH-150	3mm
PH-165	3mm
PH-180	3mm

Model	Wire diameter
PH-210	4mm
PH-240	4mm
PH-270	4mm
PH-300	4mm
PH-335	4mm
PH-370	4mm
PH-425	4mm
PH-460	4mm
PH-500	4mm
PH-525	4mm
PS-HEART	3mm
PS-ROCKET	3mm
PS-FLAG	3mm

## 2.6. Parachute replacement

When parachute needs to be replaced by damage of fabric deterioration (grab test), please contact Pasha Balloons.



	<b>Pasha Balloons Maintenance Manual</b>	<i>Ed. 4 Rev. 0 Date 19 March 2021</i>
---	--	--

### 2.7. Velcro replacement

Velcros can be replaced when they are not capable to keep the parachute attached during windy inflation, or at pilot discretion. Identical Velcro must be used for replacement. The procedure is to unpick the seam of the Velcro and sew a new one without exceeding Velcro borders to avoid zipper effect.

### 2.8. Temperature indicators (flag and tag)

Temperature tag may not be replaced, new one must be installed next to the old one. One row of stitching is enough for temperature indicators when installed.

Temperature flag link must be replaced with a new part when melted (flag dropping).

### 2.9. Preventive maintenance

Hot air balloon envelopes preventive maintenance consists on cleaning pulleys from dust to reduce rotation friction. Compressed air cleaning is recommended every 100FH (no grease is required as it may leak to the fabric).

	<b>Pasha Balloons Maintenance Manual</b>	<i>Ed. 4 Rev. 0 Date 19 March 2021</i>
---	--	--

### 3. BASKET REPAIR INSTRUCTIONS

#### 3.1. General

##### 3.1.1. Permitted damage

Damage is only permitted at wicker when it is smaller than 30mm in any direction and at top and bottom leather when the damage is not allowing to see bottom part of leather.

##### 3.1.2. Damage prevention and material information

Basket may be protected with a correct application of linseed oil for wicker and with a correct storage after cleaning. Most of used materials are natural and they experience an evolution depending on humidity and sun incidence.

#### 3.2. Wicker repair

When wicker is damaged, it must be replaced using the same weaving technique. Wicker must be replaced 200mm in both direction of damage to avoid a small piece of wicker being installed.

For the correct behavior of wicker, apply linseed oil after replacing wicker.

#### 3.3. Bottom leather repair

If damage is extensive enough that plywood is exposed, a minimum patch of 200mm shall be installed. For the installation, attach the top part to wicker following the same installation of original leather. When installed, tight the piece and staple to plywood with stainless steel staples.

#### 3.4. Top leather repair

If damage is extensive enough that foam or basket frame is exposed, leather must be repaired using a patch of 200mm. Patch is installed following original leather installation "sewing" it with 3mm polyester rope to the wicker.

#### 3.5. Rod covers replacement

If damage is extensive enough that nylon rods or basket wires are exposed, rod covers must be replaced by new ones ordered from Pasha Balloons.

	<b>Pasha Balloons Maintenance Manual</b>	<i>Ed. 4 Rev. 0 Date 19 March 2021</i>
---	--	--

### 3.6. Padded walls replacement

If damage is extensive enough that passenger is not protected from wicker, padded walls must be replaced by new ones ordered from Pasha Balloons.

### 3.7. Runners replacement

If any damage is found on basket runners, written instructions must be requested to Pasha Balloons in order to repair or replace.

### 3.8. Plywood replacement

If any damage is found on basket plywood, written instructions must be requested to Pasha Balloons in order to repair or replace.

### 3.9. Wires replacement

If any damage is found on basket wires, written instructions must be requested to Pasha Balloons in order to repair or replace.

	<b>Pasha Balloons Maintenance Manual</b>	<i>Ed. 4 Rev. 0 Date 19 March 2021</i>
---	--	--

## 4. BURNER REPAIRS

### 4.1. General

Hot air balloons burner repairs are mainly composed by preventive maintenance and lubrication procedures, not repairing damaged parts. If any damaged part cannot be replaced, please contact Pasha Balloons to receive detailed instructions.

Detailed drawings will be provided by Pasha Balloons to Falcon burner operators. Approved maintenance organization may receive this documentation from operators.

### 4.2. Main valve

Main valve is a lever-system valve. Preventive maintenance may require lubrication of valve stem. This lubrication is performed removing valve stem and applying krytox grease (see IPC document referred at section 8) to it.

To remove main valve, remove allen-key handle screws first. Then, complete main valve subassembly should be removed with spanner key. Special attention should be taken to rubber seat seal and bonded washer every time main valve body is disassembled. If any sign of damage is advised, any of these seals must be replaced.

### 4.3. Liquid valve

Liquid valve is a lever-system valve. Preventive maintenance may require lubrication of valve stem. This lubrication is performed removing valve stem and applying krytox grease (see materials section) to it.

To remove liquid valve, remove allen-key handle screws first. Then, complete liquid valve subassembly should be removed with spanner key. Special attention should be taken to rubber seat seal and bonded washer every time main valve body is disassembled. If any sign of damage is advised, any of these seals must be replaced.

	<b>Pasha Balloons Maintenance Manual</b>	<i>Ed. 4 Rev. 0 Date 19 March 2021</i>
---	--	--

#### 4.4. Pilot light

Pilot light subassembly is composed by pilot light torch and pilot light regulator.

Pilot light torch is a maintenance free subassembly, if any damage is found at this part, it should be replaced using allen screw to remove and installing the new one at the same position.

Pilot light regulator is actuated with a rotary valve. Preventive maintenance may require regulator cleaning from oils and paraffins accumulated in the fuel. In order to clean the regulator, allen key must be used to disassembly valve handle. Then, spanner key is needed to remove pilot light regulator body. Once the body is disassembled, use to spanner keys to open regulator body and clean any oil or paraffin accumulated with a soft piece of cloth or soft paper. Krytox grease may be used after cleaning on all seals.

#### 4.5. Pressure gauge

Pressure gauge is a maintenance free component. If any damaged is advertised, it must be replaced. In order to replace it, allen key must be used to unscrew protective case, then pull pressure gauge and replace with a new one.

#### 4.6. Burner coil

Burner coil is a maintenance free component. If any damage is advertised, please contact Pasha Balloons to order spare subassembly and receive detailed instructions.

#### 4.7. Fuel hose

Fuel hose is a maintenance free component. If any damage is advertised it may be replaced. To replace fuel hose, use spanner key to disassembly from burner block. When fuel hose is replaced, bonded washers must be replaced too.

## 5. RESERVED

	<b>Pasha Balloons Maintenance Manual</b>	<i>Ed. 4 Rev. 0  Date 19 March 2021</i>
---	--	---

## 6. MAINTENANCE SCHEDULES

### 6.1. General

Pasha Balloons recommends this schedule inspections for all Pasha balloons parts. Maintenance schedules are Pre-flight inspection, annual inspection and unscheduled inspections.

### 6.2. Scheduled Inspections

#### Pre-flight inspection

Before every flight, Pilot in command must perform preflight inspection to guarantee the airworthiness of the balloon.

#### Annual/100FH inspection

Pasha Balloons envelopes must be inspected in a regular basis every 12 calendar months or 100 flight hours, whichever occurs sooner. Section 6.4 checklist must be followed by inspector.

Pasha Balloons baskets and burners must be inspected in a regular basis every 12 calendar months. Section 6.4 checklist must be followed by inspector.

### 6.3. Unscheduled Inspections

#### Powerlines contact

After powerlines contact of any hot air balloons, annual inspection should be performed to check all the components keep airworthy.

#### Overheating

When temperature indicator or temperature tag show that 120°C have been exceeded, annual inspection of envelope must be performed before next flight to check all the components keep airworthy. This inspections must be performed if temperature flag link melts and flag felt to basket.

#### Transport accident

After any transport accident of the balloon, annual inspection should be performed to check all components keep airworthy.

	<b>Pasha Balloons Maintenance Manual</b>	<i>Ed. 4 Rev. 0 Date 19 March 2021</i>
---	--	--

#### 6.4. Inspection procedures

To perform a correct inspection, the adequate checklist must be used. Pre-flight inspection checklist must be used for pre-flight inspection and Annual/100FH checklist must be used for any other inspection.

For every point of the checklist, use criteria to determine if damage is present or not. Except for fabric, no damage is allowed in any part of the envelope, so this principle must be followed during all the inspection. In case any item fails the inspection criteria, it must be repaired according to section 2 of this HABMM before released to service.

Regarding grab test, please refer to section 6.5 of HABMM for diagrams and detailed instructions.

	<b>Pasha Balloons Maintenance Manual</b>	Ed. 5 Rev. 0  Date 19 August 2021
---	--	--

6.4.1. Pre-flight inspection checklists

<i>Pre-flight inspection checklist (envelope)</i>		
Envelope Component	Criteria	Pass (√) / Fail (x)
<b>Crown line</b>	Check for damage or wear.	
<b>Crown ring</b>	Check for damage and corrosion	
<b>Vertical tapes</b>	Check turnbacks at crown ring	
	Check gates at any intersection with other tape	
	Check tapes for any damage or burnt	
	Check tape protectors and turnbacks at flying cables	
<b>Horizontal tapes</b>	Check parachute edge tape	
	Check all horizontal tapes at envelope	
	Check mouth tape	
<b>Fabric panels</b>	Check for damage or holes	
	Check porosity	
	Check any sign of overheating	
	Check joints and stitching	
<b>Loops</b>	Check for damages	
<b>Centralizing lines</b>	Check for damage or abrasion	
<b>Control lines</b>	Check for damage or abrasion	
<b>Pulleys</b>	Check for damage or malfunction	
<b>Rings</b>	Check for corrosion or abrasion	
<b>Temp. sensor</b>	Check if installed and in good condition	
<b>Temperature tag</b>	Check for overheating	
<b>Flying cables</b>	Check for damage or corrosion	
<b>Karabiners</b>	Check for corrosion or malfunction	
<b>Repairs</b>	Check all repairs are done according to Maintenance Manual	
<b>Velcros</b>	Check suitability and condition (special shapes may have additional velcros at appendixes)	





# Pasha Balloons Maintenance Manual

Ed. 4  
Rev. 0

Date 19 March 2021

## *Pre-flight inspection checklist (basket)*

<b>Basket Component</b>	<b>Criteria</b>	<b>Pass (v) / Fail (x)</b>
<b>General</b>	Check the general condition of the basket for any damage.	
<b>Wires</b>	Ensure that the basket wires are free of damage and twists.	
<b>Load frame</b>	Ensure that the load frame and poles fit correctly and are free of damage.	
<b>Karabiners</b>	Ensure that the attachment points are secure and that all karabiners are screwed locked.	
<b>Fire extinguisher</b>	Check for the presence of a fire extinguisher in state of readiness.	
<b>Cylinder straps</b>	Check that cylinder straps are in place and cylinders are secured.	

## *Pre-flight inspection checklist (burner)*

<b>Burner Component</b>	<b>Criteria</b>	<b>Pass (v) / Fail (x)</b>
<b>General</b>	Check the general condition of the burner for any sign of damage.	
<b>Valves</b>	Ensure that all valves are working properly and closing after usage. Check no leak is advertised.	
<b>Jets</b>	Ensure that no jet is blocked when valve is actuated.	
<b>Coil</b>	Ensure that no damage is present at burner coil.	
<b>Pressure gauge</b>	Check for the presence of fuel gauge and marking is according to expected values of fuel pressure.	
<b>Fuel hose</b>	Check that no damage is advertised at fuel hose.	

	<b>Pasha Balloons Maintenance Manual</b>	<p style="text-align: right;">Ed. 5 Rev. 0</p> <p style="text-align: right;">Date 19 August 2021</p>
---	--	--

6.4.2. Annual inspection checklists

<b>Annual inspection checklist (envelope) – Every 12 calendar months</b>		
<b>Component</b>	<b>Criteria</b>	<b>Pass (√) / Fail (x)</b>
<b>Crown line</b>	Check for damage or wear.	
<b>Crown ring</b>	Check for damage and corrosion	
<b>Vertical tapes</b>	Check turnbacks at crown ring	
	Check gates at any intersection with other tape	
	Check tapes for any damage or burnt	
	Check tape protectors and turnbacks at flying cables	
<b>Horizontal tapes</b>	Check parachute edge tape	
	Check all horizontal tapes at envelope	
	Check mouth tape	
<b>Fabric panels</b>	Check for damage or holes	
	Check porosity	
	Check any sign of overheating	
	Check joints and stitching	
<b>Grab test</b>	Check fabric strength at top of the envelope and parachute edge is above 30lb or 13.6kg	
<b>Loops</b>	Check for damages	
<b>Centralizing lines</b>	Check for damage or abrasion	
<b>Control lines</b>	Check for damage or abrasion	
<b>Pulleys</b>	Check for damage or malfunction	
<b>Rings</b>	Check for corrosion or abrasion	
<b>Temperature sensor</b>	Check if installed and in good condition	
<b>Temperature tag</b>	Check for overheating	
<b>Flying cables</b>	Check for damage or corrosion	
<b>Karabiners</b>	Check for corrosion or malfunction	
<b>Repairs</b>	Check all repairs are done according to Maintenance Manual	
<b>Velcros</b>	Check suitability and condition (special shapes may have additional velcros at appendixes)Check suitability and condition	



## Pasha Balloons Maintenance Manual

Ed. 4  
Rev. 0

Date 19 March 2021

### *Annual inspection checklist (basket) – Every 12 calendar months*

Basket Component	Criteria	Pass (✓) / Fail (✗)
<b>General</b>	Check the general condition of the basket for damage.	
<b>Wires</b>	Ensure that the basket wires are free of damage and twists.	
<b>Load frame</b>	Ensure that the load frame and poles fit correctly and are free of damage.	
<b>Karabiners</b>	Ensure that the attachment points are secure and that all karabiners are screwed locked.	
<b>Fire extinguisher</b>	Check for the presence of a fire extinguisher in state of readiness.	
<b>Cylinder straps</b>	Check that cylinder straps are in place and cylinders are secured.	

### *Annual inspection checklist (burner) – Every 12 calendar months*

Burner Component	Criteria	Pass (✓) / Fail (✗)
<b>General</b>	Check the general condition of the burner for any sign of damage.	
<b>Valves</b>	Ensure that all valves are working properly and closing after usage. Check no leak is advertised.	
<b>Jets</b>	Ensure that no jet is blocked when valve is actuated.	
<b>Coil</b>	Ensure that no damage is present at burner coil.	
<b>Pressure gauge</b>	Check for the presence of fuel gauge and marking is according to expected values of fuel pressure.	
<b>Fuel hose</b>	Check that no damage is advertised at fuel hose.	

	<b>Pasha Balloons Maintenance Manual</b>	<i>Ed. 4 Rev. 0 Date 19 March 2021</i>
---	--	--

### 6.5. Grab test procedure

This procedure determines the correct instruction to perform grab test to hot air balloon envelope fabric.

Select one panel of the top row of the envelope and one panel from parachute, place grab test tool in an area between 10 and 20 cm from the edge of the envelope/parachute aligned to fabric thread and with a separation between the rigs of 75mm.

When tool is correctly secured, pull from both sides until the dynamometer shows 13.6kg or 30lb. If fabric fails before the minimum value, complete panel must be replaced following section 2.2.1 of HABMM.

This test will be repeated in orthogonal direction using the same criteria.

Grab test tool must be supplied by Pasha Balloons.

	<b>Pasha Balloons Maintenance Manual</b>	<i>Ed. 4 Rev. 0  Date 19 March 2021</i>
---	--	---

## 7. AIRWORTHINESS LIMITATIONS

### 7.1. Life limited parts

There is no component of Pasha Balloons products affected by life limit replacement.

### 7.2. Structural inspection interval

Validity of Certificate of Airworthiness is based on Maintenance schedules accomplishment. For Pasha Balloons, the interval of this inspections is:

- Envelopes: After one year or 100 flight hours, whichever occurs first.
- Baskets: After one year.
- Burners: After one year.

This inspection interval may be extended based on the following conditions:

- The extension is no longer than 30 days.
- 100 flight hours are not exceeded during the extension.
- The extension is not adopted for two consecutive inspections.
- The extension is correctly recorded and signed in the balloon logbook by Continuing Airworthiness Management Organization responsible of this balloon.
- Service life limits are not exceeded during the extension.
- No applicable Airworthiness Directive is pending at the moment of the extension.
- No limitations, set beforehand, are recorded in the logbook to avoid extensions.

### 7.3. Structural Inspection procedures

Refer to section 6.4 of HABMM for inspection procedures.

 <p><b>PASHA BALLOONS</b></p>	<p><b>Pasha Balloons Maintenance Manual</b></p>	<p><i>Ed. 4 Rev. 0</i></p> <p><i>Date 19 March 2021</i></p>
--	---	---

## 8. PARTS LIST

Pasha Balloons parts list is contained in document “Illustrated Part Catalogue / DO-10”. Latest version of the approved document will be published at Pasha Balloons website.